

STRING MONITORING UNIT 1225 (SMU 1225)

Item No.: 421.926



Picture may differ from original product

DESCRIPTION OF FUNCTIONS

The String Monitoring Unit was specially developed for multiple channel measurement of string currents in PV systems. Regardless of the inverter used, the measurement unit monitors the DC voltage sided strings of PV systems and enables quick identification of defects and troubleshooting.

TECHNICAL DATA

Input current:	Number:	12
	Measuring range:	0 ... 25 A DC
	Precision:	≤ 0.5 %
Input voltage:	Number:	1
	Measuring range:	0 ... 1,500 V DC
	Precision:	< 1.5 %
Input temperature:	Number:	1
	Type:	PT100 as 3-wire circuit
	Measuring range:	0 ... 300 °C
	Precision:	< 1.5 %
Digital input:	Number:	4
	Type:	PNP digital input, 24 V DC
	Maximum input current:	24 V DC
Analog current input:	Number:	1
	Type:	Current input
	Measuring range:	0 ... 20 mA
	Precision:	< 1.5 %
Analog voltage input:	Number:	1
	Type:	Voltage input
	Measuring range:	0 ... 10 V
Supply:	Supply voltage:	22 ... 27 V DC
	Power consumption:	< 3 W
Communication interface:	Standard:	RS485
	Data format:	8N1 (factory setting), 8E1, 8O1 Adjustable via Modbus
	Protocols:	Modbus RTU
	Baud rate:	2.400 bps, 4.800 bps, 9.600 bps(factory setting), 19.200 bps
	Bus address:	Defined by DIP-switches

Ambient conditions:

Operating temperature:

-20 °C ... +80 °C

Working atmosphere:

Without corrosive gas

Housing:

Dimensions (W x H x D):

241 x 108 x 52 mm

Type of installation:

DIN EN mounting rail

Weight:

550 g

SETTING OF MODBUS ADDRESS

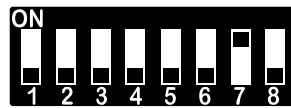
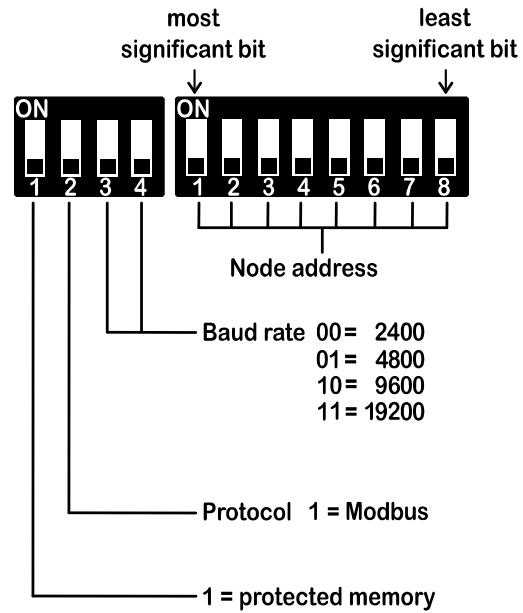

Protocol = Modbus
Parity = none
Baud rate = 19200
Address = 2



Protocol = Modbus
Parity = none
Baud rate = 9600
Address = 55